

[Martin Hurtado, Jin-Jun Xiao, and Arye Nehorai]

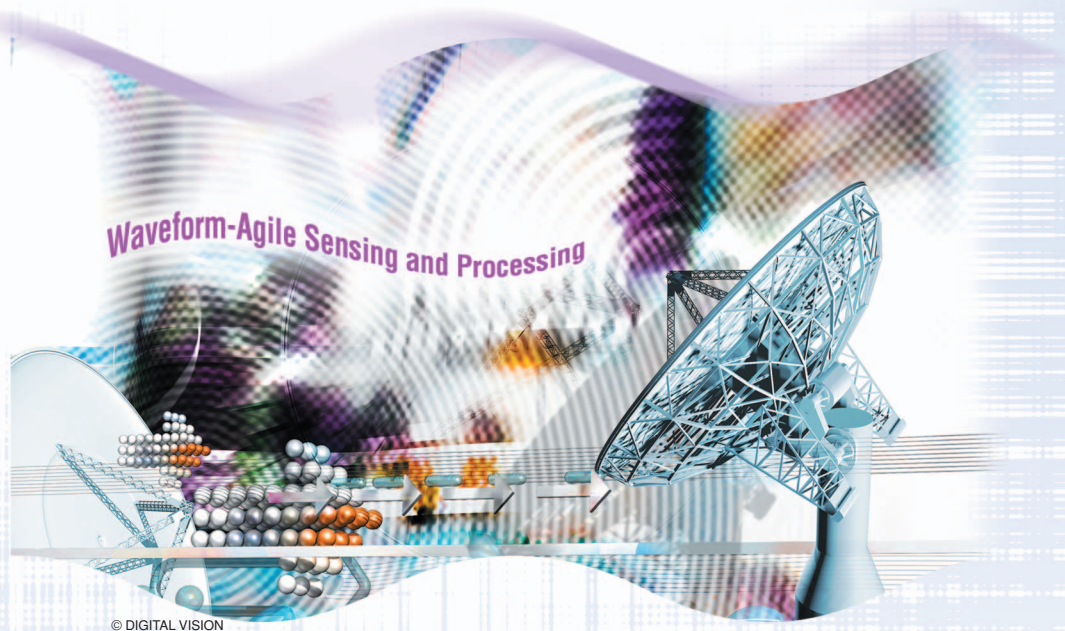

Target Estimation, Detection, and Tracking

[A look at adaptive polarimetric design]

Radar systems transmit electromagnetic (EM) waves, collect their returns, and process the recorded data to acquire information of a remote target or scene. The orientation of the oscillations of the electric and magnetic fields in the plane perpendicular to direction of travel is called polarization. Multiple polarization states of an EM signal enable it to capture multiple-copy information of a target, which results in so-called polarization diversity. Polarimetric diversity has become an important tool for detecting and tracking targets of small radar cross sections (RCS) in cluttered environments. Unlike conventional radar systems, which operate with identically polarized antennas for transmission and reception, polarimetric radar transmits and receives waveforms with different polarizations, leading to the compatibility of acquiring complete polarimetric information of the target and environment. Polarization provides more complete information about the target/environment features, such as the geometry, material, and orientation. Exploiting polarimetric information can greatly

Digital Object Identifier 10.1109/MSP.2008.930417

enhance radar capabilities, particularly when the usual signal descriptors, such as time, frequency, and bearing, are not sufficient for discriminating the target from the clutter/environment.

The effort of applying polarization diversity to enhance the radar performance can be traced back to the 1950s (see [4] and [13], and the references therein). In [24], Sinclair formulated a model to characterize an antenna when transmitting a polarized wave and calculated the voltage at the sensor output when receiving waves of any arbitrary polarization. In [21], Kennaugh demonstrated that there exist signal polarization states for which the radar receives maximum power. This idea of optimal polarization was later extended by Huynen [19]. In [20], Ioannidis and Hammers proposed a method for selecting the optimum antenna polarizations for discriminating targets in the presence of clutter. In more recent work, Novak et al. [6], [23] derived the optimal polarimetric detector. Moreover, they extended the use of product models to the full polarimetric case to account for the effects of nonhomogeneous clutter. Several authors have demonstrated that polarization can enhance the radar resolution when jointly processed with other signal features, such as bearing, frequency, or code [7], [9], [15], [16], [22]. The problem of polarimetric waveform design for improving the target detection and identification is addressed in [11]. A common assumption in the references listed above is that the statistical characteristics of the target and clutter are assumed to be known a priori. In addition, most of the existing literature about polarization diversity explores the performance of radar systems that transmit waveforms with a fixed polarization pattern (e.g., alternating between H and V polarized signals).

In this article, we explore the adaptive design of radar polarization waveforms for optimal performance, when the statistical properties of the target and clutter are unknown. We focus on a closed-loop system that sequentially estimates the target and clutter scattering parameters, and then uses these estimates to select the polarization of the subsequent waveforms. We demonstrate that the radar system performance is significantly improved when the polarization of the transmitted signal is optimally and adaptively selected to match the polarimetric aspects of the target and environment. In particular, we provide an overview of our recent results showing that the adaptive design of the radar signal polarization enables achieving optimal performance in several operating modes, including detection, estimation, and tracking. To the best of our knowledge, references [17], [18], [28], and [31] were the first to propose adaptive scheduling of radar polarization for unknown target and clutter responses.

We first discuss the problem of polarized waveform design for optimal target detection. We present a detection test statistic with a closed-form expression that incorporates information about the estimated polarimetric aspects of the target and clutter. The analysis of the detection performance is used to adaptively schedule the next transmission polarization to enhance the target detection. We select the signal polarization that maximizes the noncentrality parameter of the detection statistic distribution under the assumption that the target is present [17].

We then consider the adaptive scheduling of the transmit signal polarization for improving the estimation of the target scattering matrix. We study the estimation of the target parameters in compound-Gaussian clutter, which is characteristic of high-resolution and low-grazing-angle radars. We develop an expectation-maximization method for the maximum likelihood estimation (MLE) of the target and clutter polarimetric information. We use the Cramér-Rao bound (CRB) as the performance criterion to optimally design the signal polarization [28]. In addition, we consider the joint design of the transmit/receive polarizations to minimize the mean square error (MSE) of estimating the target scattering. We show that optimizing the receive polarization can further improve the radar sensing performance [31].

When the detection statistic exceeds the threshold indicating the presence of a target, the tracking system is initiated in order to sequentially estimate the target parameters. Hence, we consider the problem of adaptive polarized waveform design for tracking targets in the presence of clutter under a framework of sequential Bayesian inference. We implement the tracking algorithm using a sequential Monte Carlo method that is suitable for nonlinear and non-Gaussian state and measurement models. We discuss a criterion for selecting the optimal waveform polarization one step ahead by computing a recursive form of the posterior CRB (PCRB) [18].

We finally consider the optimal synthesis of a waveform with polarization control. To enable transmit polarization diversity, the radar transmitter should be capable of transmitting waveforms with control of both the polarization and spatial directivity. We consider the synthesis of such waveforms using an array of EM vector antennas (EMVA). Waveform control is achieved through carefully designing the amplitudes and phases of the weights of all antenna elements in the vector array. We show that the vector antenna array not only enables full polarization control but also significantly improves the main beam power gain [32].

PROBLEM FORMULATION

In this section, we first introduce the polarimetric signal model for a radar system. We then give a general framework for the transmit waveform polarization optimization.

MODELING ASSUMPTIONS

Throughout our work, we assume a monostatic, coherent radar that transmits waveforms consisting of a high-frequency carrier signal modulated by a narrow-band envelope. This means that the envelope changes slowly with respect to the carrier. We also assume a far-field condition, which is satisfied when the distance between the radar and the target is much larger than the largest signal wavelength. Under such a condition, the signal impinging on the target and the reflected signal observed by the radar receiver can both be treated as plane waveforms.

POLARIZED SIGNAL MODEL

To develop polarimetric signal processing techniques, we need a signal model that uses vector notation to provide a complete

description of the electrical fields of a polarized waveform. It is well known that the polarization of a plane waveform is completely determined by the spatial orientation of its electric (or magnetic) fields. Assume a plane waveform propagating along a spatial direction $\mathbf{u}(\phi, \psi)$ in a certain coordinate system, where ϕ is the azimuth angle and ψ is the elevation angle. We choose a right-handed orthonormal triad $(\mathbf{u}, \mathbf{h}, \mathbf{v})$ [22], as shown in Figure 1

$$\begin{aligned} \mathbf{u} &= [\cos \phi \cos \psi, \sin \phi \cos \psi, \sin \psi]^T \\ \mathbf{h} &= [-\sin \phi, \cos \phi, 0]^T \\ \mathbf{v} &= [-\cos \phi \sin \psi, -\sin \phi \sin \psi, \cos \psi]^T. \end{aligned} \quad (1)$$

Then the vectors \mathbf{h} and \mathbf{v} span the plane where the electric and magnetic field vectors lie. By convention, we call \mathbf{h} and \mathbf{v} the horizontal and vertical components of the plane waveforms, respectively. Thus, spanning the electric fields of the waveform in terms of the polarization basis \mathbf{h} and \mathbf{v} , we obtain

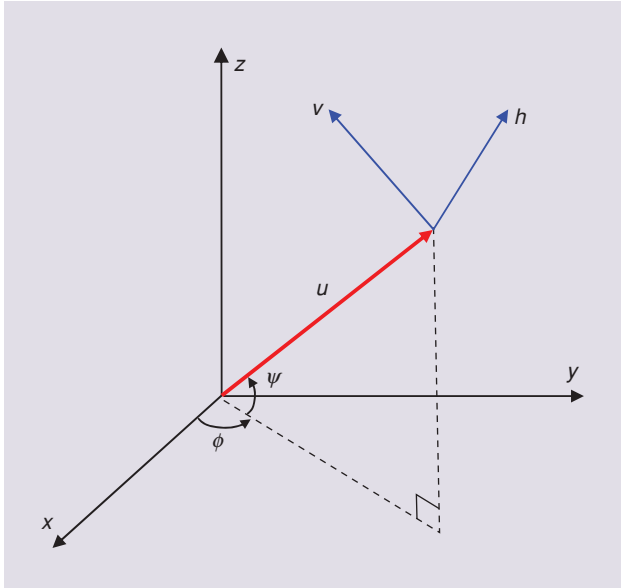

[FIG1] Coordinate system for the polarized wave.

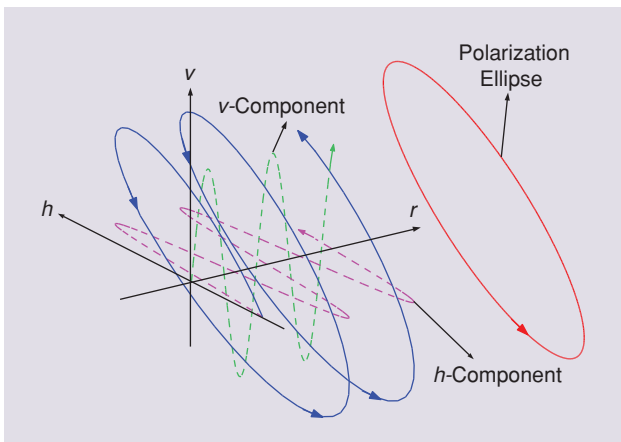

[FIG2] The illustration of the electric fields of a plane wave.

$$\boldsymbol{\xi}(t) = \begin{bmatrix} \xi_h \\ \xi_v \end{bmatrix} g(t),$$

where $g(t)$ represents the scalar complex envelope of the waveform, and ξ_h, ξ_v are the two components in the decomposition.

The polarization is the locus of the electric field vector as a function of time (see Figure 2). It describes the direction of wave oscillation in the plane perpendicular to the direction of propagation. It turns out that the wave polarization is fully determined by ξ_h and ξ_v , as stated in the following theorem:

THEOREM ([22])

Every vector $\boldsymbol{\xi}_0 = [\xi_h, \xi_v]^T \in \mathbb{C}^2$ has a unique representation

$$\boldsymbol{\xi}_0 = \|\boldsymbol{\xi}_0\| e^{j\varphi} Q(\alpha) \mathbf{w}(\beta),$$

where

$$Q(\alpha) = \begin{bmatrix} \cos \alpha & \sin \alpha \\ -\sin \alpha & \cos \alpha \end{bmatrix}, \quad \mathbf{w}(\beta) = \begin{bmatrix} \cos \beta \\ j \sin \beta \end{bmatrix},$$

and $\varphi \in (-\pi, \pi], \alpha \in (-\pi/2, \pi/2], \beta \in (-\pi/4, \pi/4]$. Moreover, $\|\boldsymbol{\xi}_0\|, \varphi, \alpha, \beta$ are uniquely determined if and only if $\xi_h^2 + \xi_v^2 \neq 0$. The angles α and β are the orientation and ellipticity of the polarization ellipse shown in Figure 3. This ellipse is depicted by the tip of the electric field vector of a monochromatic waveform in the plane spanned by \mathbf{h} and \mathbf{v} . For example, when $\beta = 0$, the resultant polarizations are linear, and moreover, $\alpha = 0$ gives a horizontal polarization and $\alpha = \pi/2$ leads to a vertical polarization. However, for $\beta = \pi/4$, the resultant polarizations are circular for any orientation angle α .

ANTENNA ARRAYS

To measure and to generate polarized signals, we need to use diversely polarized antenna arrays at the radar receiver or transmitter. Throughout this article, we assume diversely polarized antenna arrays consisting of electric and magnetic dipole antennas. We consider electric dipoles and electric loops (that are equivalent to magnetic dipoles) that are aligned with the three axes of the coordinate system. This type of array has been called an EM vector sensor (EMVS) [22] or EMVA.

At one location we can stack up to six dipole antennas (three electric dipoles and three magnetic dipoles along the x, y , and z axes) to form a full-dimensional EMVA. The six-dimensional (6-D) EMVA, in terms of the orthonormal triad $(\mathbf{u}, \mathbf{h}, \mathbf{v})$ as shown in (1) and Figure 1, has a response [22]

$$\begin{aligned} \mathbf{V}_6(\phi, \psi) &\stackrel{\text{def}}{=} [v_x^{(E)}, v_y^{(E)}, v_z^{(E)}, v_x^{(M)}, v_y^{(M)}, v_z^{(M)}]^T \\ &= \begin{bmatrix} \mathbf{h} & \mathbf{v} \\ \mathbf{v} & -\mathbf{h} \end{bmatrix}. \end{aligned} \quad (2)$$

Here, $v_x^{(E)}, v_y^{(E)}$, and $v_z^{(E)}$ denote the response of the three electric dipoles located at the x, y , and z axes respectively. Similar definitions follow for $v_x^{(M)}, v_y^{(M)}$, and $v_z^{(M)}$. We will consider a general vector antenna that consists of any subset of the six

dipoles, for which the antenna response is obtained by taking the corresponding rows of $V_6(\phi, \psi)$ and is denoted by $V(\phi, \psi)$.

Usually, antenna arrays are adopted at the radar transmitter or receiver for enhanced spatial resolution. Consider an array consisting of L vector antennas located at position $\mathbf{p}_l : l = 1, 2, \dots, L$, from which we obtain the phase vector of the planewave

$$\mathbf{a}(\phi, \psi) = \left[e^{j2\pi \mathbf{p}_1^T \mathbf{u} / \lambda}, \dots, e^{j2\pi \mathbf{p}_L^T \mathbf{u} / \lambda} \right]^T,$$

where λ is the signal wavelength. Combining it with the individual vector antenna response $V(\phi, \psi)$, we obtain that the vector antenna array response takes the form

$$\mathbf{A}(\phi, \psi) = \mathbf{a}(\phi, \psi) \otimes V(\phi, \psi), \quad (3)$$

where \otimes is the Kronecker product.

RECEIVER SIGNAL MODEL

In an active radar system, the features of the transmitted waveform are known, and the target parameters are inferred by contrasting the transmitted and backscattered waves. Then, the signal model should preserve the information about the transmitted waveform and include the target aspects.

We consider a transmitted waveform ξ with known polarization states (α, β) . As we discussed in the section ‘‘Polarized Signal Model,’’ it has a general form

$$\xi(t) = Q(\alpha)w(\beta)\|\xi\|e^{j\varphi}g(t).$$

Such a waveform impinges on the target, which has a certain polarimetric response, producing the backscattered waveform. The waveform may experience a change of polarization in the reflection process, where the change is modeled by the multiplication effect of target scattering matrices. In all, the received signal at a radar receiver has the form

$$\mathbf{y}(t) = A(\phi, \psi)S_t \xi(t) + \mathbf{c}(t) + \mathbf{e}(t), \quad (4)$$

where $A(\phi, \psi)$ is the array response, S_t is the complex scattering matrix of the target, $\mathbf{c}(t)$ is the clutter, and $\mathbf{e}(t)$ is the background white noise. Specifically, the target scattering matrix is a 2×2 matrix

$$S_t = \begin{bmatrix} s_{hh}^t & s_{hv}^t \\ s_{vh}^t & s_{vv}^t \end{bmatrix}.$$

For the monostatic radar case, $s_{hv}^t = s_{vh}^t$. In the following sections, we consider two methods of modeling the clutter process $\mathbf{c}(t)$; a compound Gaussian model, and a random scattering model in which $\mathbf{c}(t) = A(\phi, \psi)S_c \xi(t)$ with S_c being the (random) scattering matrix of the clutter. This latter model accounts for the realistic dependence of the clutter echoes on the transmitted signal.

By exploring the polarization change between $\xi(t)$ and $\mathbf{y}(t)$, we can obtain the polarimetric information of the target. Since

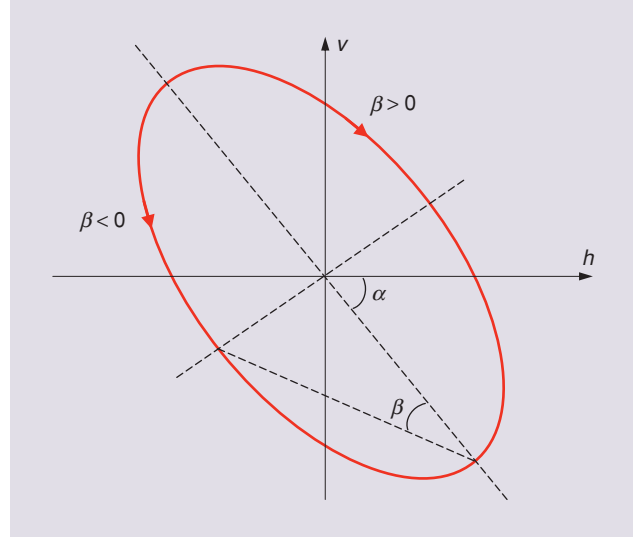

[FIG3] Polarization ellipse.

the target is embedded in clutter and white noise, as shown in (4), one of the goals of this article is to design the optimal polarization of $\xi(t)$ to best distinguish the target S_t from the noise and clutter. The general framework of designing the polarization of $\xi(t)$ is given next.

FRAMEWORK OF ADAPTIVE POLARIZATION SELECTION

The problem of polarized waveform design consists of finding the polarization parameters of $\xi(t)$ in (4) to optimize the system performance. The general procedure is described next. The radar starts sensing by sending initial probing signals. The transmitted polarized signals are backscattered by the target and the environment; see Figure 4. On the receiver side at any time-step k , using the measurements $\mathbf{y}(t) : 1 \leq t \leq k$, the radar system obtains initial information about the target and environment. Then, the system applies this newly acquired information to optimally design the polarization of the next radar waveform at $k + 1$. The design of the transmitted waveform consists of finding the signal parameters that improve the system performance of interest. In practice, the optimal design of waveforms is realized by selecting the best signal from a waveform library according to a carefully designed performance measure.

We can describe this process mathematically as follows. Let $\theta = [\alpha, \beta]^T$ denote the vector of the polarization angles. We first create a utility function $\mathcal{J}(\cdot)$ according to certain criteria that represent the system performance; then, we determine the parameters for the next transmitted waveform by optimizing (e.g., maximizing) this utility function. For any given time-step k , we select the next waveform parameters $\theta_{k+1}^{\text{opt}}$ according to

$$\theta_{k+1}^{\text{opt}} = \arg \max_{\theta \in \Theta} \mathcal{J}(\tilde{\mathbf{y}}(k+1; \theta)),$$

where Θ denotes the feasible set of θ , and $\tilde{\mathbf{y}}(k+1; \theta)$ is the predicted observation at $k + 1$ obtained by using the acquired information about the target/clutter and assuming $\xi(k+1)$ has polarization θ .

The optimal attainment of the utility function $\mathcal{J}(\cdot)$ is tied to the radar application. In our work, we consider the applications to detection, estimation, and tracking. We discuss the optimal polarization selection according to various metrics in these applications and analyze how it improves the radar performance.

In the sections “Target Detection,” “Target Estimation,” and “Target Tracking,” we present different techniques for the optimal polarization selection in different applications. Intuitively, we design optimal waveform polarizations to help distinguish the target from clutter interference. This is achieved by exploiting different statistical features of the target and scattering, and designing waveform polarizations to match the target polarimetric response while minimizing interference from clutter.

TARGET DETECTION

In this section, we address the problem of designing the signal polarization for improving the detection performance of a polarimetric radar. We consider the case of a static target in the presence of heavy clutter. In this case, the recorded data consist not only of the target echoes but also of the undesired reflections from the environment. After collecting data from the range cell under test, our task is to decide whether a target is present or not. Polarization diversity provides additional information; hence it becomes particularly useful when it is not possible to discriminate the target from the clutter using the Doppler effect. In order to perform the decision, a detection test that is a function of the radar data and the transmitted signal is needed. Then, we propose the selection of the signal polarization that will maximize the target probability of detection for the estimated target and clutter.

The development of a polarimetric detector is addressed in [17]. Starting from (4) by modeling the clutter as $c(t) = A(\phi, \psi)S_c\xi(t)$, we obtain the output of the receiver array as

$$y(t) = A(\phi, \psi)(S_T + S_c)\xi(t) + e(t), \quad (5)$$

where S_T and S_c are the scattering matrix of the target and clutter, respectively. The time samples of multiple pulses with different polarization are stacked in a column vector, and (5) is written as a linear equation in terms of the scattering coefficients

$$y = B(x_T + x_c) + e,$$

where B is a complex matrix that represents the system response, which is a function of the transmitted signal polarization

$$B = \begin{bmatrix} g \otimes A\bar{\xi}_1 \\ g \otimes A\bar{\xi}_2 \\ \vdots \end{bmatrix}, \quad \bar{\xi} = \begin{bmatrix} \xi_h & 0 & \xi_v \\ 0 & \xi_v & \xi_h \end{bmatrix},$$

and g is a vector whose entries are time samples of the signal $g(t)$. The vectors $x = [s_{hh}, s_{vw}, s_{hv}]^T$ are the scattering coefficients of the target and clutter. We assume that x_t is an unknown deterministic vector, x_c is a zero-mean complex Gaussian random vector with unknown covariance matrix Σ_c , and e is a zero-mean complex Gaussian random vector with covariance matrix $\sigma_e^2 I$, statistically independent of the clutter. Frequently, the radar dwell consists of a series of pulses that can be seen as snapshots of the range cell under test. If the pulse duration is short with respect to the dynamic of the target and its environment, it is reasonable to assume that their scattering coefficients are time invariant during each pulse. However, from pulse-to-pulse, we consider the clutter scattering coefficients as independent realizations of the same random process. This assumption may not be valid at high pulse-repetition frequency (PRF). Nevertheless, in [17] we show that this model fits well real clutter data. Refer also to [14] for a further discussion about these assumptions for remote sensing applications.

To test for a target in a range cell, we develop a generalized likelihood ratio (GLR) test that decides that the target is present if

$$T_{\text{GLR}} = \bar{y}^H B(B^H C B)^{-1} B^H \bar{y} > \gamma, \quad (6)$$

where \bar{y} and C are the sample mean vector and sample covariance matrix of radar data y , and γ is the detection threshold. It is possible to verify that (6) is a Hotelling test [1]. Hence, the statistic T_{GLR} follows a noncentral F distribution when the target is present. The noncentrality parameter is given by $\lambda \propto x_t^H [\Sigma_c + \sigma_e^2 (B^H B)^{-1}]^{-1} x_t$.

We aim to improve target detection by optimizing the design of our system. We have shown that the target probability of detection depends on the system characteristics through the noncentrality parameter λ , which in turn depends on the system response B . We recall that the system response matrix is parameterized in

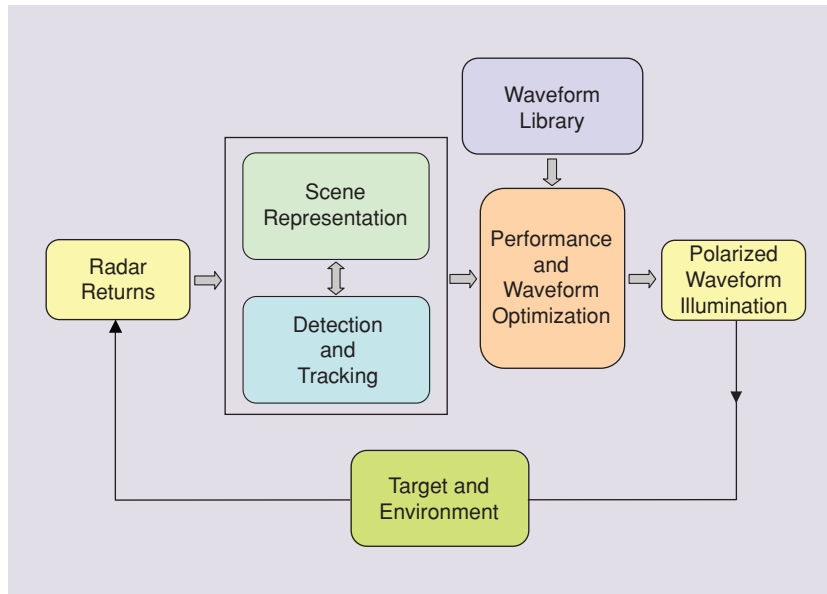

[FIG4] Block diagram of the proposed radar system exploiting polarization diversity.

terms of the signal polarization: $B = B(\theta)$, where $\theta = [\alpha, \beta]^T$. Our optimization approach consists of designing the signal polarization in order to maximize the parameter λ and, consequently, the probability of detection. Then, to improve target detection, we seek the optimal polarization

$$\theta_{k+1}^{\text{opt}} = \arg \max_{\theta} \left\{ \hat{\mathbf{x}}_t^H \left[\hat{\Sigma}_c + \sigma_e^2 (B^H B)^{-1} \right]^{-1} \hat{\mathbf{x}}_t \right\},$$

where $\hat{\mathbf{x}}_t$ and $\hat{\Sigma}_c$ are the maximum likelihood estimates of \mathbf{x}_t and Σ_c used to obtain the optimal waveform parameters for the next transmission based on the current recorded data.

In order to study the detection improvement by optimally selecting the signal polarization, we compute numerical examples. Figure 5 illustrates the gain provided by the optimally polarized radar over a conventional system using H and V pulses. The figure represents the target probability of detection as a function of the target-to-clutter ratio (TCR) for a fixed false-alarm probability of 10^{-3} . We observe that the performance improvement can reach a TCR reduction of 3 dB with respect to conventional systems. This improvement occurs when the polarimetric aspects of the target are approximately orthogonal to those of the clutter.

TARGET ESTIMATION

In this section we consider the adaptive design of waveform polarization for the target scattering estimation. We will consider two examples: transmit waveform polarization in compound Gaussian clutter and joint transmit and receive polarization optimization. For simplicity, similar to the section “Target Detection,” we assume in this section that the target scattering matrix is time-invariant. The tracking of dynamically changing (time-variant) target scattering is discussed in the section “Target Tracking.”

TRANSMIT POLARIZATION OPTIMIZATION IN COMPOUND GAUSSIAN CLUTTER

Here we consider an adaptive optimal waveform design for polarized signals under compound-Gaussian clutter models with inverse gamma distributed texture, which is often used to model clutter in high-resolution and low-grazing-angle radar [3]. Compound-Gaussian models are useful to characterize heavy-tailed clutter distributions that are frequently found in maritime and forested scenarios [12], [29]. Using the measurements that are the sum of the scattered signal from the target and the interference from the clutter, we estimate the parameters of both the target and the environment and optimally choose the signal polarizations for the subsequent transmissions to achieve the best system performance.

Let $\xi(t) = Q(\alpha)w(\beta)\|\xi\|e^{j\varphi}g(t)$ be the transmitted polarized electric field impinging on the target, and use the receive signal model as given in (4), in which $c(t)$ is modeled as compound-Gaussian distributed clutter. In other words, we can decompose the clutter as follows: $c(t) = \sqrt{u(t)}\chi(t)$, where

- $\chi(t)$ is the fast-changing speckle component accounting for local scattering, assumed to be a stationary complex

Gaussian process with zero mean and unknown covariance matrix Σ_c

- $u(t)$ is the slow-changing component called texture, which describes the variation of the local power due to the tilting of the illuminated area; texture is modeled as an inverse gamma texture distribution with pdf

$$p_u(u(t); \nu) = \frac{1}{\Gamma(\nu)} \nu^\nu u(t)^{-\nu-1} e^{-\nu/u(t)},$$

where $\Gamma(\cdot)$ is the gamma function.

Since it is mathematically intractable to find a closed-form solution for the ML estimates of S_t , Σ_c , and ν from the likelihood function of the observed data in (4), we use the expectation-maximization (EM) algorithm [28]. We adopt the general multivariate analysis of variance (GMANOVA) model [8] using the PX-EM algorithm in [27]. The model (4) is a special GMANOVA model with identity spatio-temporal matrix. The estimation algorithm is composed of two loops. In the inner loop, the ML estimates of S_t and Σ_c are computed for a fixed ν value using PX-EM algorithm. In the outer loop, we estimate ν with the estimation results from the inner step using alternate projection until ν converges. A more detailed description is as follows:

- *Estimating S_t and Σ_c* : In the PX-E step, we calculate the conditional expectations of the complete-data sufficient statistics assuming that all unknown parameters $\{S_t, \Sigma_c, \nu\}$ are known from the complete data log-likelihood. In the PX-M step, we estimate S_t and Σ_c from these expectations. The derivation of these estimates from the sufficient statistics is explained in [8] in detail.

- *Estimating ν* : We compute the ML estimate of ν by maximizing the observed-data concentrated log-likelihood function with respect to the estimates of $\{S_t, \Sigma_c\}$ obtained using the PX-EM algorithm.

We use the criterion of minimizing the CRB of estimating S_t for sequential transmit signal polarization design. By treating the real and imaginary parts of the entries of S_t as the parameters,

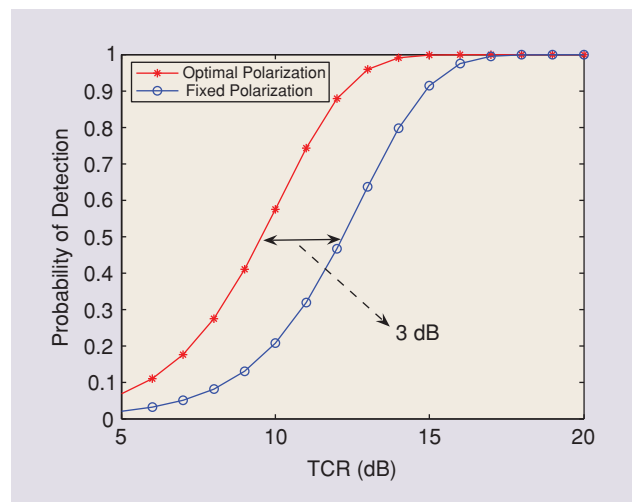

[FIG5] Detection performance of the GLR test statistic T_{GLR} as a function of the target-to-clutter ratio.

we obtain the CRB matrix is of size 6×6 , if we in addition assume that the radar is monostatic, i.e., $s_{hv}^t = s_{vh}^t$. We minimize the determinant of the CRB matrix. This is equivalent to maximizing the determinant of the Fisher information matrix (FIM), for which the detailed computation is given in [28].

In Figure 6, we show the MSE of estimating the entries of S_t versus number of pulses. We choose the scattering matrix (that is to be estimated) $S_t = [2j, 0.5; 0.5, -j]$ to generate the data. In order to start the adaptive design algorithms, we send 10 pilot signals to obtain initial information about Σ_c . Since at each step the most efficient waveform polarization (in terms of minimizing CRB) is selected, the optimal adaptive algorithm performs much better than the fixed-polarization algorithm. Moreover, when the number of pulses increases, the performance gap enlarges, since the optimal design is done sequentially.

JOINT TRANSMIT AND RECEIVE POLARIZATION OPTIMIZATION

We have also considered the joint transmit and receive polarization optimization for target scattering estimation in [31]. We cast the problem as the optimal design of the radar sensing matrix when both clutter interference and background noise are present, where the sensing matrix is determined by the transmit/receive polarizations and waveform power levels. The optimal design of the sensing matrix for a linear Gaussian model has been studied in [10] and has been shown to have an analytical solution. In our model, the resultant optimization problem is highly nonlinear because of the coupling of the clutter with the transmit waveforms but can be recast as a semi-definite programming (SDP) problem, which is numerically efficiently solvable.

Specifically, we assume that the radar transmits waveforms with transmit polarization $\xi = [\xi_h, \xi_v]^H$ and power P . In addition, we assume that the receive antenna has polarization $\eta = [\eta_h, \eta_v]^H$. We model the clutter by a (random) scattering matrix S_c and thus obtain the following observation model:

$$y(t) = \sqrt{P(t)} \boldsymbol{\eta}(t)^H (S_t + S_c) \boldsymbol{\xi}(t) + e(t);$$

$$t = 1, 2, \dots, m. \quad (7)$$

It is obvious that the previous model is not linear in either $\boldsymbol{\xi}$ or $\boldsymbol{\eta}$. Introducing $\mathbf{b}(t) = \sqrt{P} [\xi_h \eta_h, \xi_v \eta_h, \xi_h \eta_v, \xi_v \eta_v]^T$, $\mathbf{x}_t = [s_{hh}^t, s_{vv}^t, s_{hv}^t, s_{vh}^t]$, and $\mathbf{x}_c = [s_{hh}^c, s_{vv}^c, s_{hv}^c, s_{vh}^c]$, we can rewrite (7) as

$$y(t) = \mathbf{b}(t)^T \mathbf{x}_t + \mathbf{b}(t)^T \mathbf{x}_c + e(t).$$

Thus we obtain a linear model where the goal is to design the optimal observation vectors $\mathbf{b}(t)$, the decomposition of which leads to the desired $\boldsymbol{\xi}(t)$, $\boldsymbol{\eta}(t)$, and $P(t)$. For \mathbf{x}_t and \mathbf{x}_c , we further assume a complex Gaussian distribution with known covariance matrix Σ_t and Σ_c , respectively [6], [14], [23]. Introducing $B = [\mathbf{b}(1), \mathbf{b}(2), \dots, \mathbf{b}(m)]^T$ and $\mathbf{y} = [y(1), y(2), \dots, y(m)]^T$, we obtain that the minimum MSE D of estimating \mathbf{x}_t from \mathbf{y} satisfies $D^{-1} = \Sigma_t^{-1} + B^H (B \Sigma_c B^H + \sigma_e^2 I_m)^{-1} B$. Thus, to choose the optimal polarization and power scheduling to minimize the MSE of estimating S_t subject to the average power constraint P using m diversely polarized pulses, we obtain the following optimization problem:

$$\begin{aligned} \min_{B, D} \quad & \text{tr}(D) \\ \text{s.t.} \quad & D^{-1} = \Sigma_t^{-1} + B^H (B \Sigma_c B^H + \sigma_e^2 I_m)^{-1} B \\ & \text{tr}(B B^H) \leq mP, \quad D \geq 0. \end{aligned}$$

The above problem is apparently neither linear nor convex in B or D . In [31], we reformulated the above problem in a convex form to make it efficiently solvable.

Figure 7 plots the MSE performance of estimating S_t based on two schemes: i) optimally designed $\mathbf{b}(t)$ and ii) conventional $\mathbf{b}(t)$ where both $\boldsymbol{\xi}$ and $\boldsymbol{\eta}$ alternate between H and V . The signal-to-noise ratio (SNR) is defined to be P/σ_e^2 . The MSE is relative to the actual value of S_t in units of dB. As can be seen in the figure, the optimally designed $\mathbf{b}(t)$ based on polarization selection and power scheduling leads to a power gain of around 5 dB.

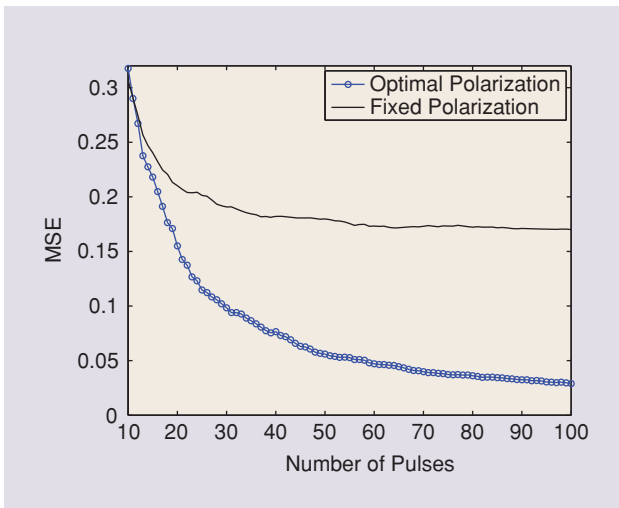

[FIG6] MSE of estimating the elements of the scattering matrix.

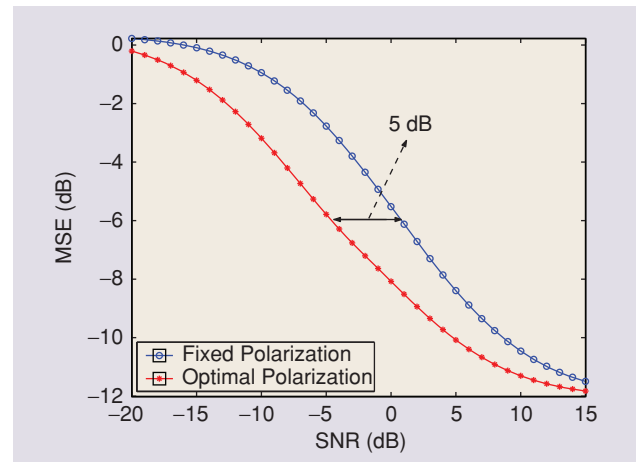

[FIG7] MSE performance comparison for the estimation of the scattering matrix with or without transmit/receive polarization optimization.

TARGET TRACKING

The problem of tracking a dynamic target consists of computing sequential estimates of the target parameters at each radar time step or pulse-repetition interval. Since the target evolves in time, the fixed waveform may not match the operational scenario, and the system performance can be severely degraded. Thus, to achieve the best tracking performance, we propose an adaptively designed radar signal polarization in response to the estimated and predicted target's dynamic parameters.

To achieve optimal tracking performance, we combine sequential Bayesian filtering for parameter estimation and polarization design of the radar signal. This framework based on sequential Bayesian inference includes four phases: i) creation of a dynamic state model and a statistical measurement model, ii) prediction and update of the posterior density, iii) Bayesian state estimation, and iv) optimal waveform selection. A detailed discussion of this approach is presented in [18].

In order to define the filtering problem, we first define the dynamic state and measurement models

$$\begin{aligned} z_k &= f(z_{k-1}, v_{k-1}) \\ y_k &= h(z_k, e_k), \end{aligned}$$

where z is the target state vector at time-step k , y is the measurement process, and v and e are independent white process. The state vector z includes the target position x , y , z , velocity components \dot{x} , \dot{y} , \dot{z} in a Cartesian coordinate system, and the target scattering parameters given by (5). We assume a target moving at constant velocity, with scattering parameters nearly constant. Then, we obtain a linear target dynamic-state model given by

$$z_k = Fz_{k-1} + v_{k-1},$$

where F is the transition matrix, and the process noise v_k is assumed to be zero mean Gaussian distributed with known covariance Σ_v . Extending (5) to account for the signal delay τ and Doppler shift ω_D , the output of the antenna array is

$$y(t) = A(\phi, \psi)(S_t + S_c)\xi(t - \tau)e^{j\omega_D t} + e(t),$$

where

$$\begin{aligned} \phi &= \arctan(y/x) & \psi &= \arctan\left(\frac{z}{\sqrt{x^2 + y^2}}\right) \\ r &= \sqrt{x^2 + y^2 + z^2} & \omega_D &= \frac{2\pi}{\lambda r}(\dot{x}x + \dot{y}y + \dot{z}z). \end{aligned}$$

Therefore, the measurement model is a nonlinear function of the state parameters.

The tracking problem is solved by computing the posterior probability density function (pdf) $p(z_k | y_{1:k})$, based on the measurements $y_{1:k}$ up to time k . Under the Bayesian inference framework, we can obtain recursive formulas to predict and update this pdf when the new measurements y_k are available [2]. However, this recursive procedure cannot be determined analytically

when the models are nonlinear or non-Gaussian. In that case, we apply a particle filter to implement the former Bayesian algorithm for our tracking problem characterized by a nonlinear measurement model. The particle filter algorithm is a sequential Monte Carlo method in which the key idea is to represent the required posterior density function by a set of sample particles with associated weights [2]

$$p(z_k | y_{1:k}) \approx \sum_i w_k^{(i)} \delta(z_k - z_k^{(i)}),$$

where $w_k^{(i)}$ are the weights associated with the particles $z_k^{(i)}$.

After obtaining the current belief $p(z_k | y_{1:k})$, we can obtain an optimal estimate of the current state z_k . Under the Bayesian framework, the estimate is calculated by optimizing a utility function. For example, when we apply a minimum-mean-squared error (MMSE) criterion, the estimate is the conditional mean

$$\begin{aligned} \hat{z}_k &= \int z_k p(z_k | y_{1:k}) dz_k \\ &\approx \sum_i w_k^{(i)} z_k^{(i)}. \end{aligned}$$

To solve the optimization of the signal polarization, a criterion that evaluates the system performance is required. We use the PCRB, which provides a lower bound on the MSE matrix for the random state vector. We recall that the inverse of the PCRB is the Bayesian information matrix (BIM) on the estimated parameters. We adopt the recursive equation developed in [26] to update the BIM at each time-step k . For the particular case of a linear state model with additive Gaussian noise, this recursive BIM can be written as (see [26])

$$J_{k+1} = [\Sigma_v + FJ_k(\Theta_k)^{-1}F^T]^{-1} + \Gamma_{k+1}(\Theta_{k+1}),$$

where Θ_k and Θ_{k+1} are the polarization parameters at time-step k and $k+1$, respectively, and

$$\Gamma_{k+1} = E_{y_{k+1}, z_{k+1}} \left[-\Delta_{z_{k+1}}^{z_{k+1}} \log p(y_{k+1} | z_{k+1}) \right],$$

where Δ denotes the second-order derivative. Note that Γ_{k+1} is calculated by averaging over all possible values of y_{k+1} . That means we do not need to know the specific values of the next measurements to calculate J_{k+1} . In our sequential polarization design algorithm, we attempt to minimize the error on the target state estimation. Then, we propose the weighted trace of the predicted PCRB as a criterion for selecting the optimal radar trajectory

$$\theta_{k+1}^{opt} = \arg \min_{\theta} \text{Tr} \left[\Pi J_{k+1}^{-1} \right],$$

where Π is a weighting matrix used to equalize the magnitude of different parameters in the state vector and to ensure that the units of the cost function are consistent. Additionally, the matrix Π can be used to provide different priorities to subsets of parameters by assigning a higher weight.

We use numerical examples to study the performance of the proposed adaptive waveform design method for tracking targets in the presence of clutter. Figure 8 shows the tracking results,

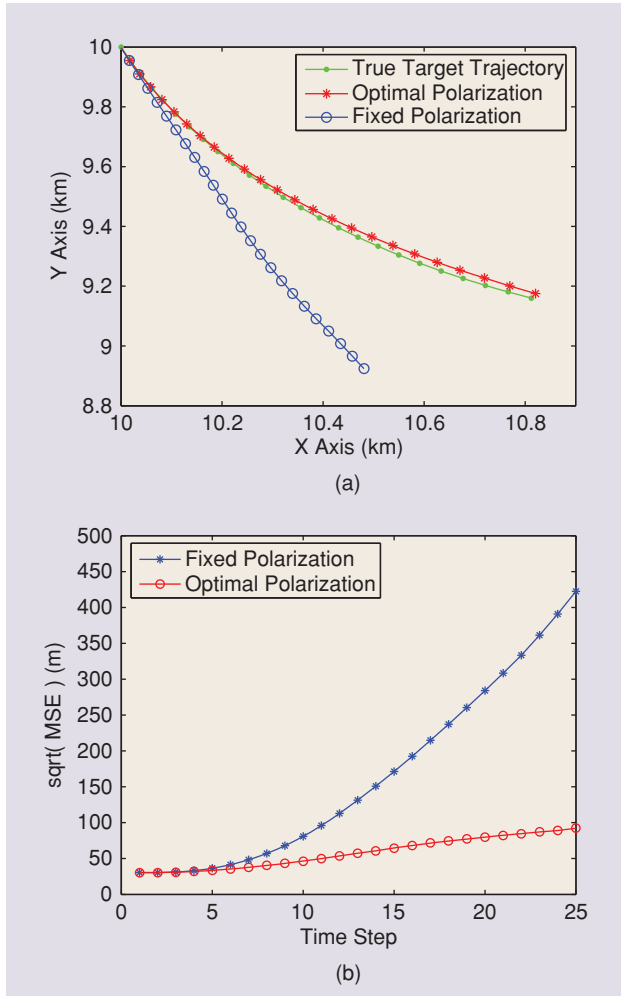

[FIG8] (a) Comparison of the averaged tracking results between adaptive and fixed polarization schemes. (b) Square root of the averaged MSE for the target position.

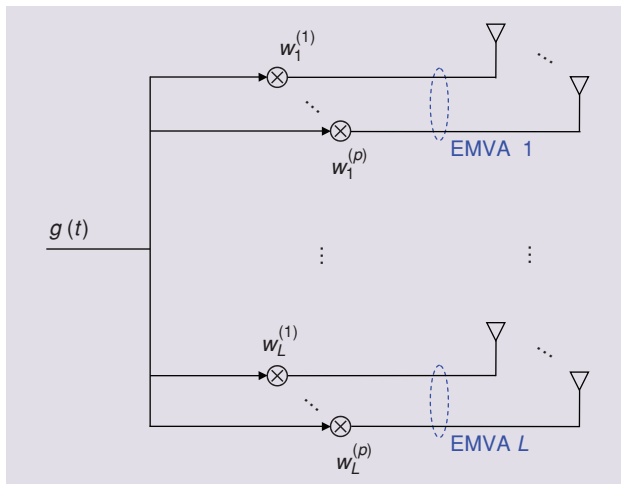

[FIG9] Vector antenna array.

averaged over 100 Monte Carlo simulations, of a target that moves parallel to the horizontal plane at a constant velocity describing a circular trajectory. For the fixed waveform, the signal polarization is unfavorable, because it is close to the polarimetric response of the clutter. Hence, the received signal is highly corrupted by clutter reflections and the tracking filter is not capable of following the target. On the other hand, the adaptive waveform method, although it was also started with the same polarization, immediately selects the waveform that matches the estimated polarimetric aspects of the target, increasing the energy of the signal reflected from the target and reducing the clutter reflections. Therefore, the tracking performance for the adaptive waveform selection scheme is significantly better than that of the fixed waveform scheme, as shown in Figure 8(b).

BEAM-PATTERN SYNTHESIS

In previous sections, we have shown that exploiting the waveform polarization significantly improves the sensing performance of radar. In this section, we consider the synthesis of beam-patterns at the radar transmitter, which allows the free control of the beam-pattern polarization. In traditional beam-pattern synthesis of a scalar array, radio signals from a set of small nondirectional antenna elements are combined with different weights to achieve the beam spatial directionality. The beam emitted by such arrays are of fixed polarization and cannot be controlled. To obtain a beam with full polarization control, we propose to use an array of vector antennas. We design complex weights for individual array elements to achieve a beam with both the desired spatial power density and the desired polarizations. Our goal is to explore the potential of EMVA from the transmitter point of view. By exploiting the full EM-field components, we study how vector antennas can achieve polarization control and improve the spatial power pattern of the array.

The antenna array we consider consists of L EMVA located at $\mathbf{p}_l \in \mathbb{R}^3 : 1 \leq l \leq L$. Each antenna in the array further has $1 \leq p \leq 6$ orthogonal dipole elements. The antennas are driven by the same carrier signal with wavelength λ and convex envelope $g(t)$. The antenna currents (or weights) on the p dipoles in the n th EMVA are denoted by $\mathbf{w}_l = [w_l^{(1)}, w_l^{(2)}, \dots, w_l^{(p)}]^T$ (see Figure 9). We further introduce $\mathbf{w} = [w_1^T, w_2^T, \dots, w_L^T]^T \in \mathbb{C}^{pL \times 1}$.

For any spatial direction (ϕ, ψ) , we use $\boldsymbol{\xi}(\phi, \psi)$ to denote the electrical fields emitted from this vector antenna array. According to (3), it holds that $\boldsymbol{\xi}(\phi, \psi) = A(\phi, \psi)^T \mathbf{w}$, where $A(\phi, \psi) = \mathbf{a}(\phi, \psi) \otimes V_p(\phi, \psi) \in \mathbb{C}^{pL \times 2}$ and $V_p(\phi, \psi)$ is the vector antenna response, which consists of p rows of $v_6(\phi, \psi)$, depending on the p dipole elements that are specifically chosen [see (2)]. We propose a problem of designing the antenna weights \mathbf{w} to synthesize a beam pattern with the following properties:

- i) The mainbeam, assumed pointing at a direction (ϕ_0, ψ_0) , has a desired power of 0 dB and polarization (α, β) .
- ii) The power of sidelobes in a region of interest (denoted by S_u) are suppressed.

Compared with a scalar array, the beam-pattern synthesis in a vector array enforces an additional polarization constraint on the main beam.

There are various criteria invoked in suppressing the sidelobe power while maintaining the mainlobe power and polarization. Two conventional criteria are the total sidelobe power minimization or the maximum sidelobe power minimization. In this article, we focus on the latter only, leading to the following optimization problem:

$$\begin{aligned} \min_{w, \tau} \quad & \tau \\ \text{s.t.} \quad & \|\xi(\phi, \psi)\|^2 \leq \tau; \quad \forall (\phi, \psi) \in \mathcal{S}_u \\ & \xi(\phi_0, \psi_0) = \begin{bmatrix} \cos \alpha & -\sin \alpha \\ \sin \alpha & \cos \alpha \end{bmatrix} \begin{bmatrix} \cos \beta \\ j \sin \beta \end{bmatrix} \\ & \xi(\phi, \psi) = A(\phi, \psi)^T w, \quad \forall (\phi, \psi). \end{aligned}$$

It is easy to see that the above problem is convex and is, in fact, a second-order cone programming (SOCP) [5]. In the subsequent numerical examples, we adopt self-dual minimization (SeDuMi) [25], an optimization toolbox, to solve the SOCP formulated above.

We analyze by simulations the performance of beam-pattern synthesis using an array of vector antennas. We use arrays of $L = 6, 12,$ and 18 antennas, respectively, which are located on each of the three axes and are symmetric about the origin. In each antenna, we consider antenna elements with $2 \leq p \leq 6$. For each p , the dipole elements are chosen according to Table 1. In addition, we choose $(\phi_0, \psi_0) = [45^\circ, 45^\circ]$ and $(\alpha, \beta) = [30^\circ, 45^\circ]$.

The achieved spatial power patterns for $L = 18$ and $p = 6$ are given in the first plot in Figure 10. In the second plot, all three curves for different array size $L = 6, 12, 18$ show that when p increases from one to two, polarization control is enabled but there is no additional power gain [30], while for $p \geq 2$, besides the polarization control, the mainbeam power gain versus the sidelobes improves significantly and is actually almost linearly proportional to p . We thus conclude that the EMVA array has the advantage of enabling the control of the beam-pattern polarization and virtually increasing the array size, since multiple EM fields at each antenna are exploited.

CONCLUSIONS

We addressed the problem of designing the optimal signal polarization for radar sensing applications. We reviewed some of our recent results on the adaptive selection of the radar transmit waveform polarizations, where the goal is to explore polarization diversity through an adaptive design. Polarization diversity provides information that can be exploited to discriminate targets from clutter. We showed that the optimal selection of the polarization significantly improves the radar system capabilities compared with fixed polarization schemes. The main topics we discussed are:

- The polarization should be designed to match the polarimetric aspects of the target and environment, where the goal is to use polarimetric information to better separate the target from clutter interference.
- The polarization design is achieved by the optimization of a performance function that is closely associated with the radar operation modes, such as detection, estimation, and tracking.

[TABLE 1] DIPOLE ELEMENTS THAT ARE USED IN THE SIMULATIONS.

	$V_x^{(E)}$	$V_y^{(E)}$	$V_z^{(E)}$	$V_x^{(M)}$	$V_y^{(M)}$	$V_z^{(M)}$
$p = 1$			✓			
$p = 2$			✓			
$p = 3$	✓	✓	✓			✓
$p = 4$	✓	✓	✓		✓	✓
$p = 5$	✓	✓	✓	✓	✓	✓
$p = 6$	✓	✓	✓	✓	✓	✓

- The polarization control of the radar waveform can be achieved using electromagnetic vector antennas. In particular, an array of such vector antennas fully enables polarization control and also enhanced beam-pattern spatial resolution through exploiting multiple EM-fields at a fixed physical location.

We demonstrated that radar systems supporting agile polarization greatly outperform conventional sensing systems. However, to further improve the radar capabilities, several research challenges need to be considered. From the statistical signal processing perspective, these include the development of more realistic models for the target and clutter scattering, appropriate performance measures for various critical scenarios, and robust but efficient optimization algorithms. Moreover, the problem of signal polarization design

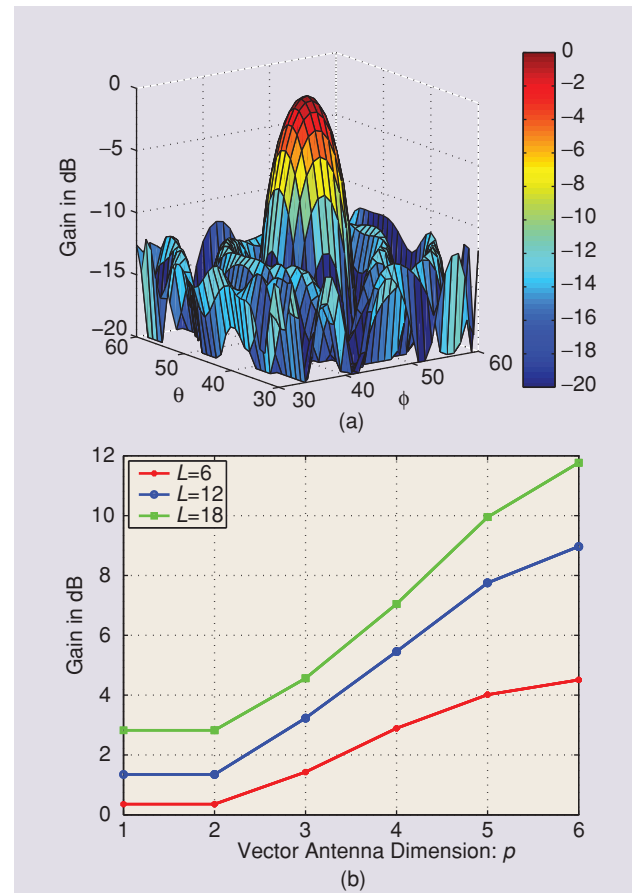

[FIG10] (a) Illustration of achieved spatial power pattern. (b) Power gain versus antenna dimensionality p .

can be extended to other radar applications, such as sequential detection and target classification.

ACKNOWLEDGMENTS

We thank Dr. J. Wang and Dr. T. Zhao for their contribution to some of the results reviewed in this article. This work was supported by the Department of Defense under the Air Force Office of Scientific Research MURI Grant FA9550-05-0443, AFOSR Grant FA 9550-05-1-0018, and DARPA under NRL Grant N00173-06-1G006.

AUTHORS

Martin Hurtado (mhurta3@ese.wustl.edu) received the B.Eng. and M.Sc. degrees in electrical engineering from the National University of La Plata, Argentina, in 1996 and 2001, respectively. He received his Ph.D. degree in electrical engineering from Washington University in St. Louis, Missouri in 2007. He is a postdoctoral research associate in the Department of Electrical and Systems Engineering at Washington University in St. Louis. His research interests are in the area of statistical signal processing, detection and estimation theory and their applications in sensor arrays, communications, and remote sensing systems, as well as electromagnetic theory and antenna design.

Jin-Jun Xiao (xiao@ese.wustl.edu) received the B.Sc. degree in applied mathematics from Jilin University, Changchun, China, in 1997, and the M.Sc. degree in mathematics and Ph.D. degree in electrical engineering from the University of Minnesota, Twin Cities, in 2003 and 2006, respectively. He is currently a postdoctoral fellow at Washington University in St. Louis, Missouri. His current research interests are in statistical signal processing, optimization, multiuser information theory, and their applications to sensors and sensor networks. He is a Member of the IEEE.

Arye Nehorai (nehorai@ese.wustl.edu) is chair of the Electrical and Systems Engineering Department of Washington University in St. Louis, where he holds the Eugene and Martha Lohman Professorship. From 2000 to 2002, he was Editor-in-Chief of the *IEEE Transactions on Signal Processing*. He received the IEEE Signal Processing Society 1989 Society's Senior Award for Best Paper as well as the 2004 Magazine Paper Award, and was coauthor of the IEEE Signal Processing Society 2003 Young Author Best Paper Award. He was Distinguished Lecturer of the IEEE Signal Processing Society from 2004 to 2005 and received the 2006 IEEE Signal Processing Society Technical Achievement Award. He is a Fellow of the IEEE and the Royal Statistical Society.

REFERENCES

- [1] T.W. Anderson, *An Introduction to Multivariate Statistical Analysis*. Hoboken, NJ: Wiley, 2003.
- [2] M.S. Arulampalam, S. Maskell, N. Gordon, and T. Clapp, "A tutorial on particle filters for online nonlinear/non-Gaussian Bayesian tracking," *IEEE Trans. Signal Process.*, vol. 50, pp. 174–188, Feb. 2002.
- [3] A. Balleri, A. Nehorai, and J. Wang, "Maximum likelihood estimation for compound-Gaussian clutter with inverse gamma texture," *IEEE Trans. Aerosp. Electron. Syst.*, vol. 43, pp. 775–779, Apr. 2007.
- [4] W.M. Boerner and Y. Yamaguchi, "A state-of-the-art review in radar polarimetry and its applications in remote sensing," *IEEE Aerosp. Electron. Syst. Mag.*, vol. 5, pp. 3–6, June 1990.

- [5] S. Boyd and L. Vandenberghe, *Convex Optimization*. Cambridge, U.K.; Cambridge Univ. Press, 2003.
- [6] R.D. Chaney, M.C. Bud, and L.M. Novak, "On the performance of polarimetric target detection algorithms," *IEEE Aerosp. Electron. Syst. Mag.*, vol. 5, pp. 10–15, Nov. 1990.
- [7] R.T. Compton, "On the performance of a polarization sensitive adaptive array," *IEEE Trans. Antennas Propagat.*, vol. 29, pp. 718–725, Sept. 1981.
- [8] A. Dogandžić and A. Nehorai, "Generalized multivariate analysis of variance: A unified framework for signal processing in correlated noise," *IEEE Signal Process. Mag.*, vol. 20, pp. 39–54, Sept. 2003.
- [9] E. Ferrara and T. Parks, "Direction finding with an array of antennas having diverse polarizations," *IEEE Trans. Antennas Propagat.*, vol. 31, pp. 231–236, Mar. 1983.
- [10] D.R. Fuhrmann, "One-step optimal measurement selection for linear Gaussian estimation problems," in *Proc. Int. Waveform Diversity & Design Conf.*, Pisa, Italy, June 2007, pp. 224–227.
- [11] D.A. Garren, A.C. Odom, S.U. Pillai, and J.R. Guerci, "Full polarization matched illumination for target detection and identification," *IEEE Trans. Aerosp. Electron. Syst.*, vol. 38, pp. 824–837, July 2002.
- [12] F. Gini, A. Farina, and F. Lombardini, "Effects of foliage on the formation of k-distributed SAR imagery," *Signal Process.*, vol. 75, pp. 161–171, June 1999.
- [13] D.G. Giuli, "Polarimetric modeling and parameters estimation with applications to remote sensing," *Proc. IEEE*, vol. 74, pp. 245–269, Feb. 1986.
- [14] B. Hochwald and A. Nehorai, "Polarization diversity in radars," *IEEE Trans. Signal Process.*, vol. 43, pp. 1923–1935, Aug. 1995.
- [15] S.D. Howard, A.R. Calderbank, and W. Moran, "A simple signal processing architecture for instantaneous radar polarimetry," *IEEE Trans. Inform. Theory*, vol. 53, pp. 1282–1289, Apr. 2007.
- [16] M. Hurtado and A. Nehorai, "Performance analysis of passive low-grazing-angle source localization in maritime environments using vector sensors," *IEEE Trans. Aerosp. Electron. Syst.*, vol. 43, pp. 780–789, Apr. 2007.
- [17] M. Hurtado and A. Nehorai, "Polarimetric detection of targets in heavy inhomogeneous clutter," *IEEE Trans. Signal Process.*, vol. 56, pp. 1349–1361, Apr. 2008.
- [18] M. Hurtado, T. Zhao, and A. Nehorai, "Adaptive polarized waveform design for target tracking based on sequential Bayesian inference," *IEEE Trans. Signal Process.*, vol. 56, pp. 1120–1133, Apr. 2008.
- [19] J.R. Huynen, "Phenomenological theory of radar targets," Ph.D. dissertation, Technical Univ., Delft, The Netherlands, 1970.
- [20] G. Ioannidis and D. Hammers, "Optimum antenna polarizations for target discrimination in clutter," *IEEE Trans. Antennas Propagat.*, vol. 27, pp. 357–363, May 1979.
- [21] E.M. Kennaugh, "Effects of type of polarization on echo characteristics," Antennas Laboratory, The Ohio State Univ., Columbus, OH, Tech. Rep. 389-1–389-24, 1954.
- [22] A. Nehorai and E. Paldi, "Vector-sensor array processing for electromagnetic source localization," *IEEE Trans. Signal Process.*, vol. 42, pp. 376–398, Feb. 1994.
- [23] L.M. Novak, M.B. Sechtin, and M.J. Cardullo, "Studies of target detection algorithms that use polarimetric radar data," *IEEE Trans. Aerosp. Electron. Syst.*, vol. 25, pp. 150–165, Mar. 1989.
- [24] G. Sinclair, "The transmission and reception of elliptically polarized waves," *Proc. IRE*, vol. 38, pp. 148–151, Feb. 1950.
- [25] J.F. Sturm, "Using SeDuMi 1.02, a Matlab toolbox for optimization over symmetric cones," Commun. Res. Lab., McMaster Univ., Hamilton, Canada [Online]. Available: <http://sedumi.mcmaster.ca>
- [26] P. Tichavský, C. Muravchik, and A. Nehorai, "Posterior Cramér-Rao bounds for discrete-time nonlinear filtering," *IEEE Trans. Signal Process.*, vol. 46, pp. 1386–1396, May 1998.
- [27] J. Wang, A. Dogandžić, and A. Nehorai, "Maximum likelihood estimation of compound-Gaussian clutter and target parameters," *IEEE Trans. Signal Process.*, vol. 54, pp. 3884–3898, Oct. 2006.
- [28] J. Wang and A. Nehorai, "Adaptive polarimetric design for a target in compound-gaussian clutter," in *Proc. Int. Waveform Diversity and Design Conf.*, Lihue, HI, Jan. 2006.
- [29] K.D. Ward, C.J. Baker, and S. Watts, "Maritime surveillance radar. i. radar scattering from the ocean surface," *Proc. Inst. Elect. Eng. F*, vol. 137, pp. 51–62, Apr. 1990.
- [30] J.-J. Xiao and A. Nehorai, "Optimal beam pattern synthesis of a polarized array," in *Proc. IEEE Statistical Signal Processing Workshop*, Madison, WI, Aug. 2007, pp. 463–467.
- [31] J.-J. Xiao and A. Nehorai, "Polarization optimization for scattering estimation in heavy clutter," in *Proc. IEEE Int. Conf. Acoustics, Speech, and Signal Processing*, Las Vegas, NV, Mar. 2008, pp. 1473–1476.
- [32] J.-J. Xiao and A. Nehorai, "Polarized beam pattern synthesis using a vector antenna array," in *IEEE Trans. Signal Process.*, 2008, to be published. 